

HI96831

Ethylene Glycol Refractometer



INSTRUCTION MANUAL

**Dear
Customer,**

Thank you for choosing a Hanna Instruments product.
Please read this instruction manual carefully before using this instrument.

This manual will provide you with the necessary information for correct use of this instrument, as well as a precise idea of its versatility.

If you need additional technical information, do not hesitate to e-mail us at tech@hannainst.com or view our worldwide contact list at www.hannainst.com.

All rights are reserved. Reproduction in whole or in part is prohibited without the written consent of the copyright owner, Hanna Instruments Inc., Woonsocket, Rhode Island, 02895, USA.

Preliminary Examination	4
General Description.....	5
Specifications	6
Principle of Operation	7
Measurement Units.....	8
Functional Description.....	9
Display Elements.....	10
Measurement Guidelines	10
Calibration Procedure.....	11
Measurement Procedure.....	12
To Change Measurement Unit.....	13
To Change Temperature Unit	14
Making a Standard Solution.....	15
Battery Replacement.....	16
Error messages.....	17
Accessories.....	18

Remove the instrument from the packing materials and examine carefully to ensure no damage has occurred during shipping. If any damage has occurred, please contact your local Hanna Instruments Office.

Each **HI96831** instrument is supplied with:

- 9 V battery
- Instruction manual
- Plastic pipette
- Quality Certificate

Note: Save all packing material until you are sure that the instrument functions correctly. A defective instrument must be returned in its original packing.

The **HI96831** Digital Refractometer is a rugged portable, water resistant device that utilizes the measurement of refractive index to determine the % volume and freezing point of ethylene glycol based coolants or antifreeze.

The **HI96831** device benefits from Hanna Instruments' years of experience as a manufacturer of analytical instruments. The digital refractometer eliminates the uncertainty associated with mechanical refractometers and is easily portable for use in the field to optimize your cooling system.

The **HI96831** refractometer is an optical device that is simple and quick to use. Samples are measured after a simple user calibration with distilled or deionized water. Within seconds, the refractive index and temperature are measured and converted into one of two measurement units; % Volume or Freezing Point. The instrument utilizes internationally recognized references for unit conversion and temperature compensation for ethylene glycol solutions (e.g. CRC Handbook of Chemistry and Physics, 87th Edition).

The temperature (in °C or °F) is also displayed on the large dual level display along with helpful message codes.

Key features include:

- IP65 waterproof protection
- Automatic Temperature Compensation (ATC)
- Battery operation with Low Power indicator (BEPS)
- Automatically turns off after 3 minutes of non-use

SPECIFICATIONS

Range	% Volume : 0.0 to 100.0 % V/V
	Freezing point: 0.0 to -50.0 °C (32.0 to -58.0 °F)
	°C (°F): 0.0 to 80.0 °C (32.0 to 176.0 °F)
Resolution	% Volume: 0.1 % V/V
	Freezing Point: 0.1 °C (0.1 °F)
	°C (°F): 0.1 °C (0.1 °F)
Accuracy	%Volume: ±0.2% V/V
	Freezing Point: ±0.5 °C (±1.0 °F)
	°C (°F): ±0.3 °C (±0.5 °F)
Temperature Compensation	Automatic between 10.0 and 40.0 °C (32.0 - 104.0 °F)
Measurement Time	Approximately 1.5 seconds
Minimum Sample Volume	100 µL (cover prism totally)
Light Source	Yellow Led
Sample Cell	Stainless Steel ring and flint glass prism
Case Material	ABS
Enclosure Rating	IP65
Battery Type / Life	9V/ 5000 readings
Auto-Off	After 3 minutes of non-use
Dimensions	192 x 102 x 69 mm (7.6 x 4.1 x 2.7 ")
Weight	350 g (12.3 oz.)

The %Brix determination is made by measuring the refractive index of a solution. Refractive Index is an optical characteristic of a substance and the number of dissolved particles in it. Refractive Index is defined as the ratio of the speed of light in empty space to the speed of light in the substance. A result of this property is that light will “bend”, or change direction, when it travels through a substance of different refractive index. This is called refraction. When passing from a material with a higher to lower refractive index, there is a critical angle at which an incoming beam of light can no longer refract, but will instead be reflected off the interface.

The critical angle can be used to easily calculate the refractive index according to the equation:

$$\sin(\theta_{\text{critical}}) = n_2 / n_1$$

Where n_2 is the refractive index of the lower-density medium; n_1 is the refractive index of the higher-density medium.

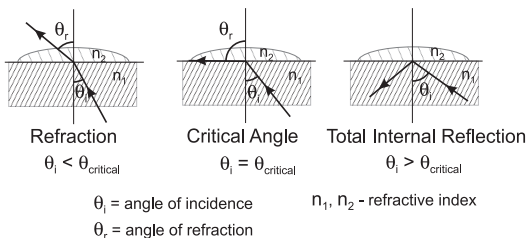

In the [HI96831](#) refractometer, light from an LED passes through a prism in contact with the sample. An image sensor determines the critical angle at which the light is no longer refracted through the sample.

Specialized algorithms then apply temperature compensation to the measurement and convert the refractive index to: % Volume or Freezing Point.

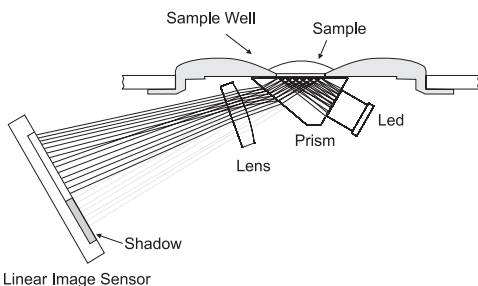

Freezing point is displayed as a temperature from 0.0 to - 50.0 °C corresponding to 0-58 % by volume. The display blinks the freezing point when the concentration of Ethylene glycol is greater than 78% concentration by volume. When the display shows “LO”, the freezing point is at a minimum (below -50 °C).

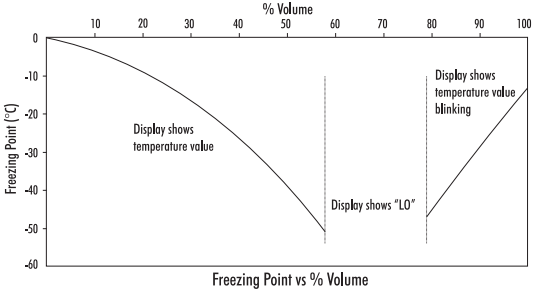

TOP VIEW

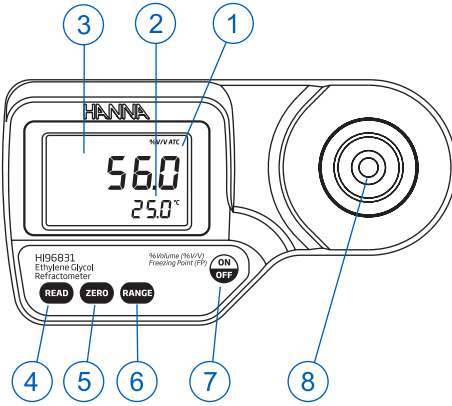

1. Liquid Crystal Display (LCD)
2. Secondary Display
3. Primary Display
4. **READ** Key (User Measurement)
5. **ZERO** Key (User Calibration)
6. **RANGE** Key (User Measurement Unit)
7. **ON/OFF**
8. Stainless Steel Sample Well and Prism

BOTTOM

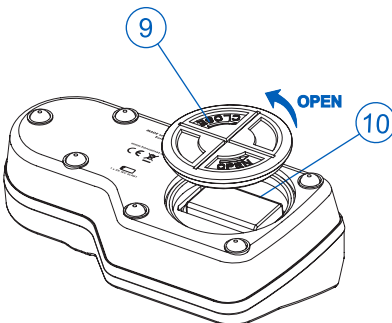

9. Battery Cover
10. Battery Compartment

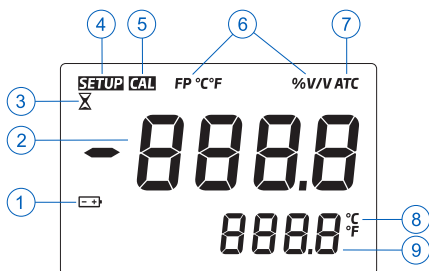

1. Battery (blinks when low battery condition detected)
2. Primary Display (displays measurement and error messages)
3. Measurement in Progress Tag
4. SETUP: Factory Calibration Tag
5. CAL: Calibration Tag
6. Measurement Unit
7. Automatic Temperature Compensation
(blinks when temperature exceeds 0.0-40.0 °C / 32.0-104.0 °F range)
8. Temperature Units
9. Secondary Display (displays temperature measurements; when blinking, temperature has exceeded operation range: 0.0-80.0 °C / 32.0-176.0 °F)

- Handle instrument carefully. Do not drop.
- Do not immerse instrument under water.
- Do not spray water to any part of instrument except the “sample well” located over the prism.
- The instrument is intended to measure ethylene glycol solutions. Do not expose instrument or prism to solvents that will damage it. This includes most organic solvents and extremely hot or cold solutions.
- Particulate matter in a sample may scratch the prism. Absorb sample with a soft tissue and rinse sample well with deionized or distilled water between samples.
- Use plastic pipettes to transfer all solutions. Do not use metallic tools such as needles, spoons or tweezers as these will scratch the prism.
- Cover sample well with hand if measuring in direct sun.

Calibration should be performed daily, before measurements are made, when the battery has been replaced, between a long series of measurements, or if environmental changes have occurred since the last calibration.

1. Press the **ON/OFF** key, then release. Two instrument test screens will be displayed briefly; all LCD segments followed by the percentage of remaining battery life. The meter will then briefly display an indication of the measurement units set. When LCD displays dashes, the instrument is ready.

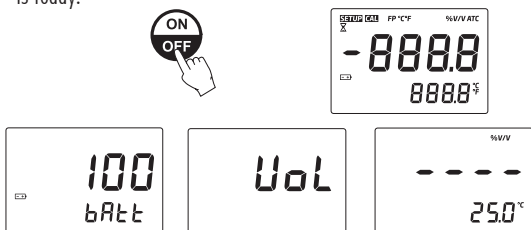

2. Using a plastic pipette, fill the sample well with distilled or deionized water. Make sure the prism is completely covered.



Note: If the ZERO sample is subject to intense light such as sunlight or another strong source, cover the sample well with your hand or other shade during the calibration.

3. Press the **ZERO** key. If no error messages appear, your unit is calibrated. (For a description of **ERROR MESSAGES** see page 17).



Note: The 0.0 screen will remain until a sample is measured or the instrument is turned off.

4. Gently absorb the ZERO water standard with a soft tissue. Use care not to scratch the prism surface. Dry the surface completely. The instrument is ready for sample measurement.

Note: If the instrument is turned off the calibration will not be lost.



Verify the instrument has been calibrated before taking measurements.

1. Wipe off prism surface located at the bottom of the sample well. Make sure the prism and sample well are completely dry.



2. Using a plastic pipette, drip sample onto the prism surface. Fill the well completely.

Note: If the temperature of the sample differs significantly from the temperature of the instrument, wait approximately 1 minute to allow thermal equilibration.



3. Press the **READ** key. The results are displayed as % Volume or Freezing Point.



Note: The last measurement value will be displayed until the next sample is measured or the instrument is turned off. Temperature will be continuously updated.

The ATC tag blinks and automatic temperature compensation is disabled if the temperature exceeds the 0.0-40.0 °C / 32.0-104.0 °F range.

4. Remove sample from the sample well by absorbing with a soft tissue.
5. Using a plastic pipette, rinse prism and sample well with distilled or deionized water. Wipe dry. The instrument is ready for the next sample.



Press the **RANGE** key to select the measurement units. The instrument toggles between the two measurement scales each time the key is pressed and the primary display indicates "VoL" % Volume or "FrPt" for Freezing Point. When the instrument displays the screen with 4 dashes, the instrument is ready for measurement.

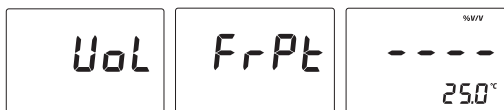

To change the temperature measurement unit from Celsius to Fahrenheit (or vice versa), follow this procedure.

1. Press and hold the **ON/OFF** key continuously for approximately 8 seconds. The LCD will display the "all segment" screen followed by a screen with the model number on the primary display and the version number on the secondary display. Continue pressing the **ON/OFF** key.

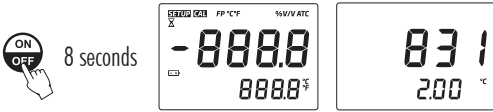

2. While continuing to hold the **ON/OFF** key, press the **ZERO** key. The temperature unit will change from °C to °F or vice versa.

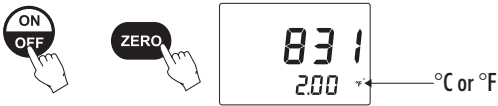

Note: The selected unit will be used in Freezing Point mode.

To make a Ethylene Glycol Solution, follow the procedure below:

- To make an X % ethylene glycol solution volumetrically add X mL of high purity ethylene glycol (CAS #: 107-21-1; MW 62.068) to a 100 mL Grade A volumetric flask.
- Use distilled or deionized water to bring the flask close to the total volume, mix, allow time for the solution to return to room temperature.
- Once the solution has returned to room temperature use distilled or deionized water to bring the total volume to 100 mL. Mix solution well before use.

	Ethylene Glycol	Total Volume	Expected Freezing Point Value
10 % V	10.00 mL	100.00 mL	-3.8 °C (25.2 °F)
40 % V	40.00 mL	100.00 mL	-26.3 °C (-15.4 °F)







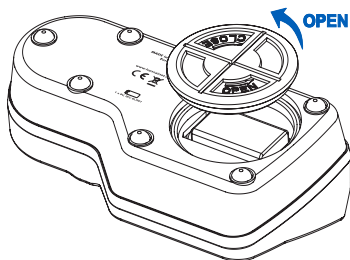

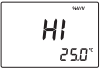

BATTERY REPLACEMENT

To replace the instrument's battery, follow these steps:

- Make sure the instrument is off.
- Turn instrument upside down and remove the battery cover by turning it counterclockwise.

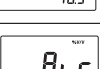

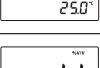
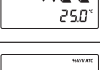
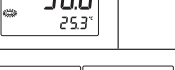
- Extract the battery from its location.
- Replace with a new 9V battery making sure to observe polarity.
- Insert the back battery cover and fasten it by turning clockwise to engage.

Error Code		Description
"Err"		General failure. Cycle power to instrument. If error persists, contact your local Hanna Instruments Office.
"LO" primary display		Sample exceeds minimum measurement range.
"HI" primary display		Sample exceeds maximum measurement range.
"LO" primary display Cal segment ON		Wrong solution used to zero instrument. Use deionized or distilled water. Press ZERO .
"HI" primary display Cal segment ON		Wrong solution used to zero instrument. Use deionized or distilled water. Press ZERO .
"t LO" primary display Cal segment ON		Temperature exceeds ATC low limit (10.0 °C) during calibration.
"t HI" primary display Cal segment ON		Temperature exceeds ATC high limit (40.0 °C) during calibration.
"Air"		Prism surface insufficiently covered.
"ELt"		Too much external light for measurement. Cover sample well with hand.
"nLt"		LED light is not detected. Contact your local Hanna Instruments Office.
Battery segment blinking		< 5% of battery life is remaining.
Temperature values are blinking "0.0°C" or "80.0°C"		Temperature measurement out of range (0.0 to 80.0 °C).
ATC segment blinking		Outside temperature compensation range (10.0 to 40.0 °C).
SETUP segment blinking		Factory calibration lost. Contact your local Hanna Instruments Office.

Code	Description
HI740157P	Plastic refilling pipette (20 pcs.)
HI740029P	9V battery (10 pcs.)

Warranty

HI96831 is warranted for two years against defects in workmanship and materials when used for their intended purpose and maintained according to instructions.

This warranty is limited to repair or replacement free of charge.

Damage due to accidents, misuse, tampering or lack of prescribed maintenance is not covered.

If service is required, contact your local Hanna Instruments Office. If under warranty, report the model number, date of purchase, serial number and the nature of the problem. If the repair is not covered by the warranty, you will be notified of the charges incurred. If the instrument is to be returned to Hanna Instruments, first obtain a Returned Goods Authorization number from the Technical Service department and then send it with shipping costs prepaid. When shipping any instrument, make sure it is properly packed for complete protection.

To validate your warranty, fill out and return the enclosed warranty card within 14 days from the date of purchase.

Hanna Instruments reserves the right to modify the design, construction or appearance of its products without advance notice.

World Headquarters

Hanna Instruments Inc.
Highland Industrial Park
584 Park East Drive
Woonsocket, RI 02895 USA
www.hannainst.com

Local Office

Hanna Instruments USA
270 George Washington Highway
Smithfield, RI 02917
Phone: 800.426.6287
Fax: 401.765.7575
e-mail: tech@hannainst.com